

Anbauanleitung Seilwindenanbausatz Isuzu D-max ab Bj. 2012

*Installation instruction winch mounting kit
Isuzu D-max from 2012 on*

Best.-Nr.: 16- 8110

AL: 2017 – 03



**Hier sehen sie den fertig montierten Seilwindenanbausatz.
Bevor sie mit der Montage beginnen, lesen sie bitte diese Anleitung
und die Bedienungsanleitung der Seilwinde gut durch.**

Achtung:

Bei Fahrten im öffentlichen Straßenverkehr muss das Rollenseilfenster mit
der Kunststoffabdeckung abgedeckt werden

Here you see the ready mounted winch mounting kit.

*Before you start the assembly, please read and understand this manual and
the manual of the winch.*

Stückliste Seilwindenanbausatz Isuzu D-max ab Bj.2012

Partlist winch mounting kit Isuzu D-max from 2012 on

Best.nr.: 16- 811

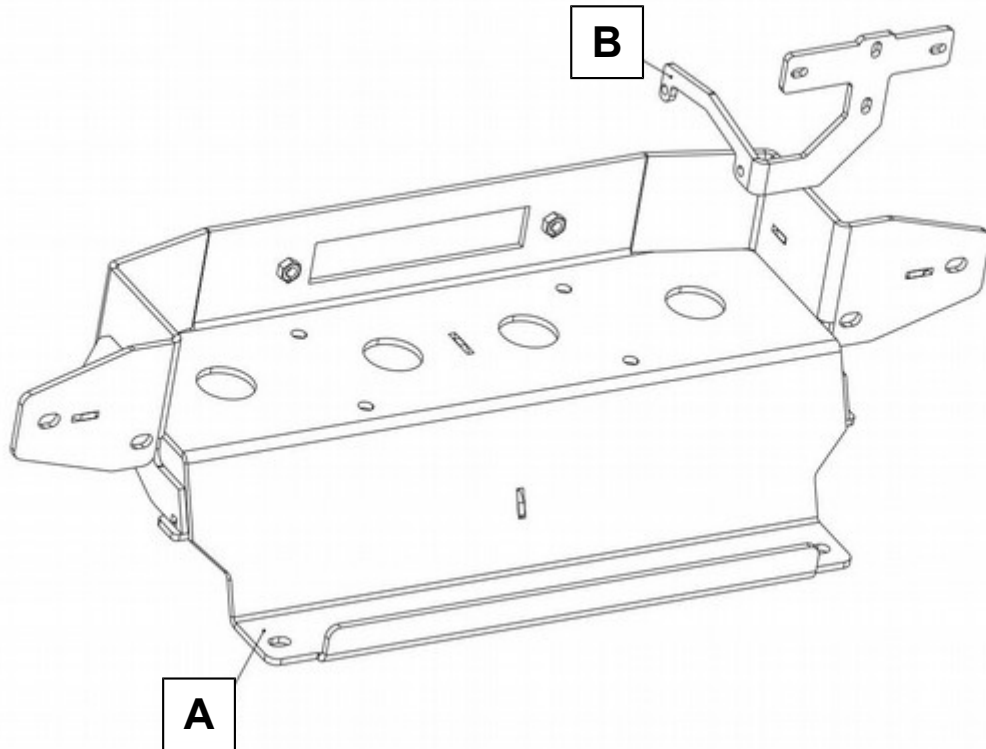

1 x Seilwindenaufnahme (A)	6 x Schraube M 10 x 1,25 x 30
1 x Schaltkastenhalter (B)	2 x Schraube M 10 x 25
1 x Anbauanleitung AL 2017	2 x U-Scheibe M 10
1 x Gutachten	6 x U-Scheibe M 10 x 30 x 3
1 x Typaufkleber	8 x Federring M 10
	2 x Schraube M 6 x 16
	2 x U-Scheibe M6 x 20 x 2
	2 x Federring M6
	4 x Rundstecker (rot) 0,5 – 1mm (ZEON 8)
	4 x Rundsteckhülse(rot) 0,5 – 1mm (ZEON 8)
	2 x Schraube M 5 x 20 (ZEON 8)
	4 x U- Scheibe M 5 (ZEON 8)
	2 x Federring M 5 (ZEON 8)
	2 x Mutter M 5 (ZEON 8)
	2 x Linsenkopfschraube M 6 x 20 (ZEON 8)
	2 x Mutter M 6 (ZEON 8)

Bei Verwendung einer WARN ZEON 8 Seilwinde empfehlen wir die Verwendung des „ 80 cm ZEON control pack relocation kit 1- 89965“ !

If you want to install a WARN ZEON 8 ,we recommend the ” (31”) ZEON control pack relocation kit 1- 89965 “ !

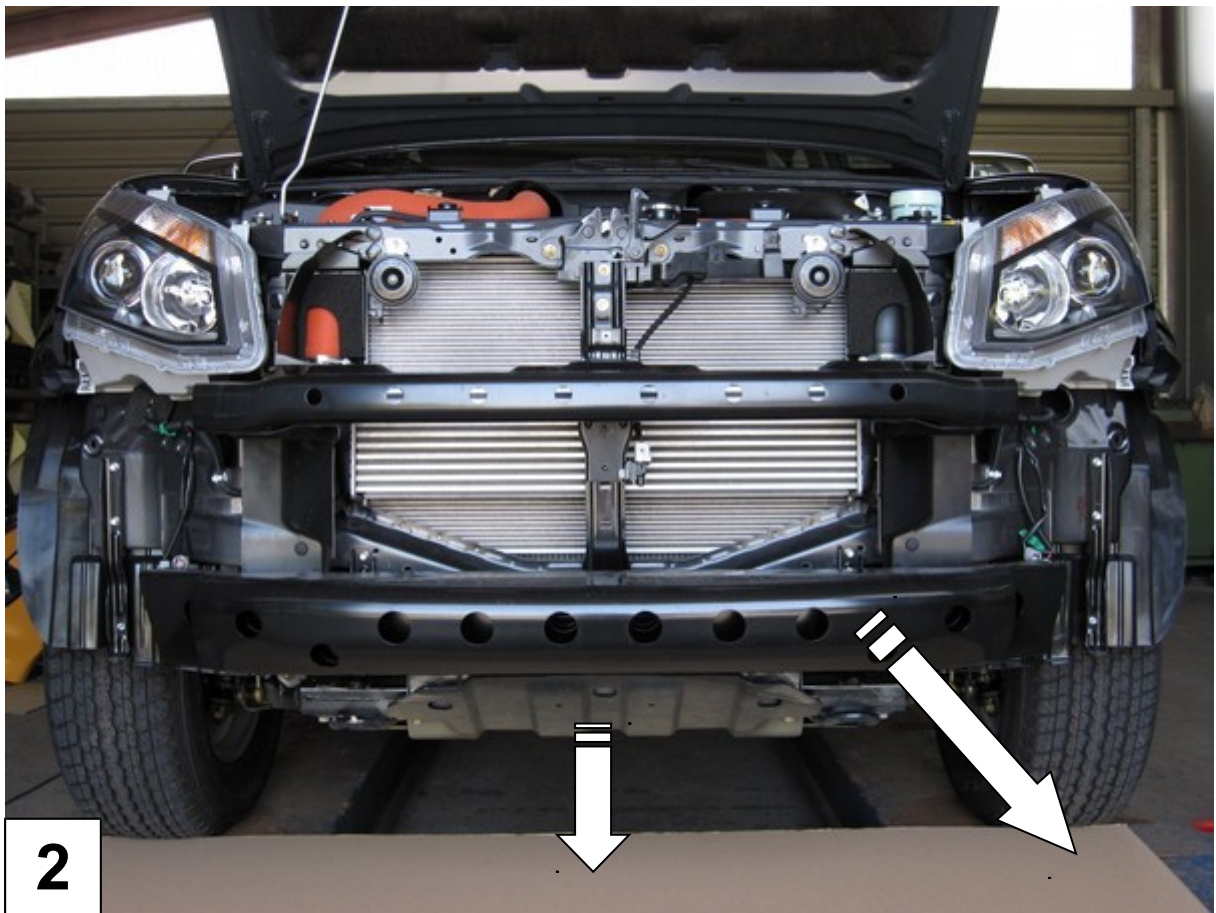
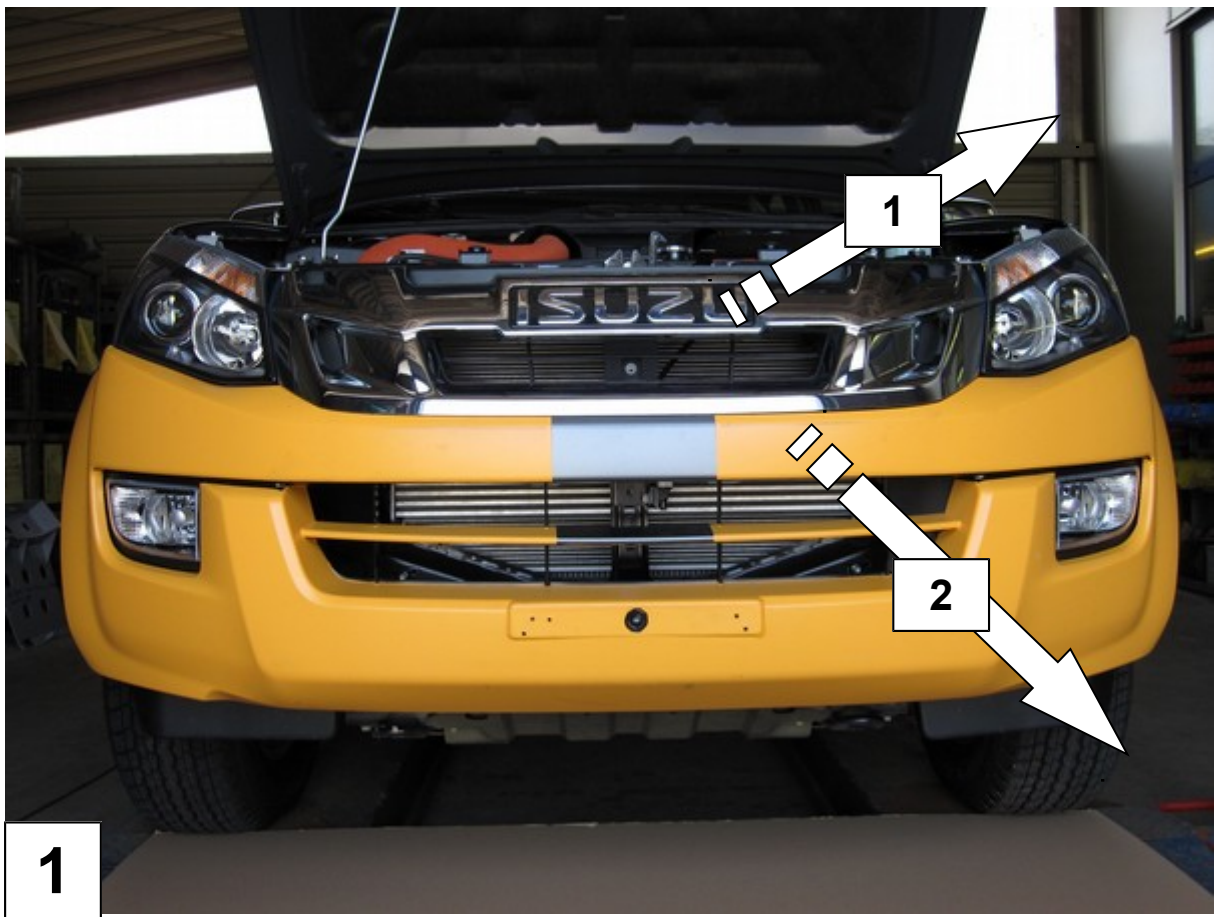

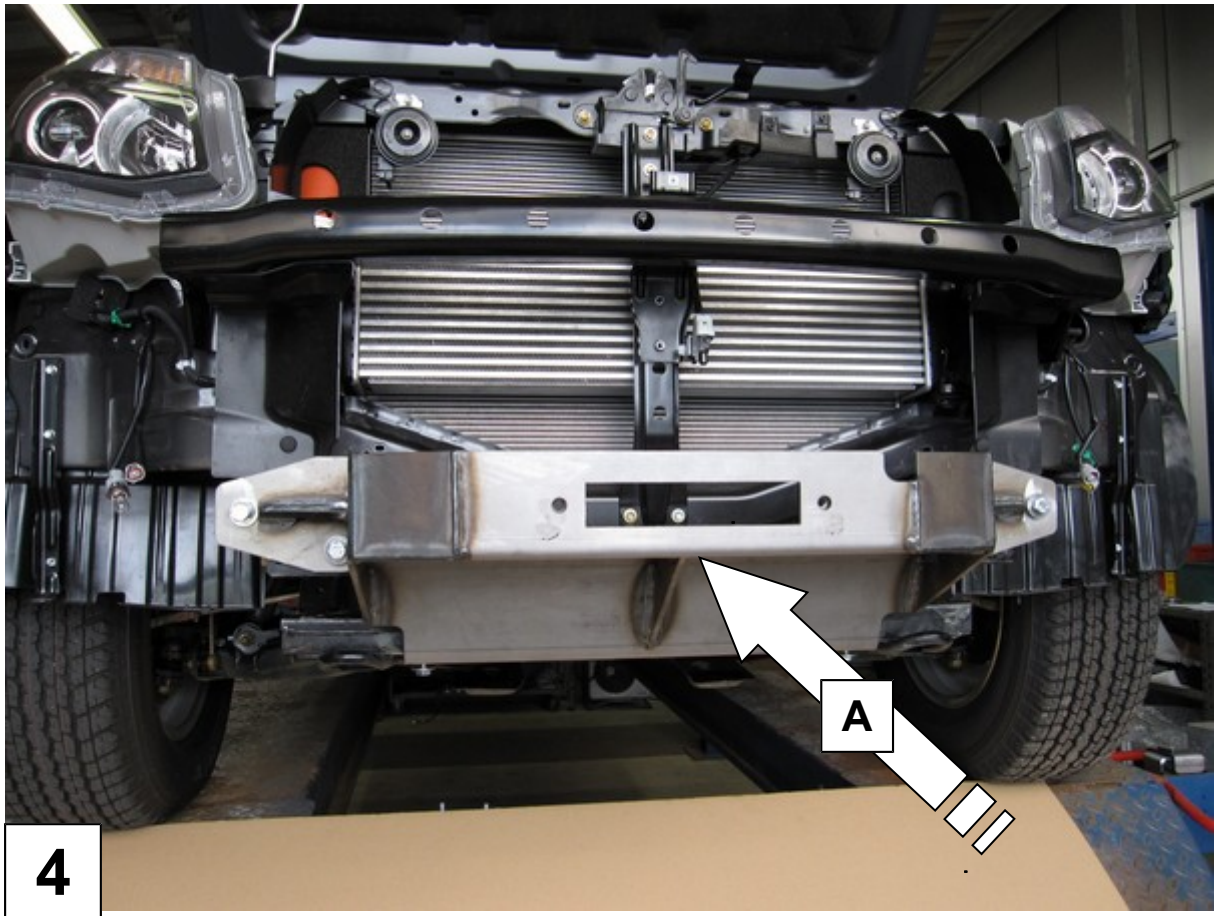

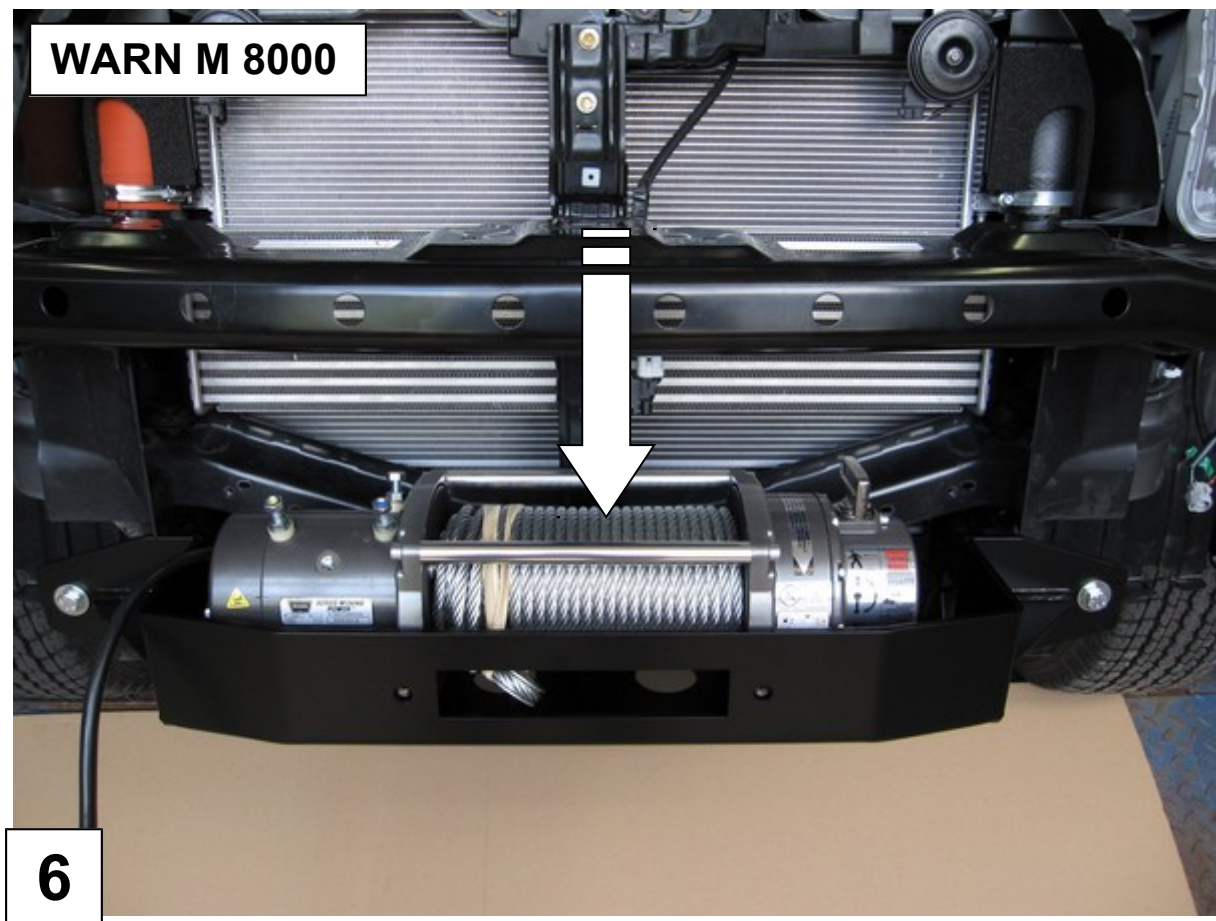
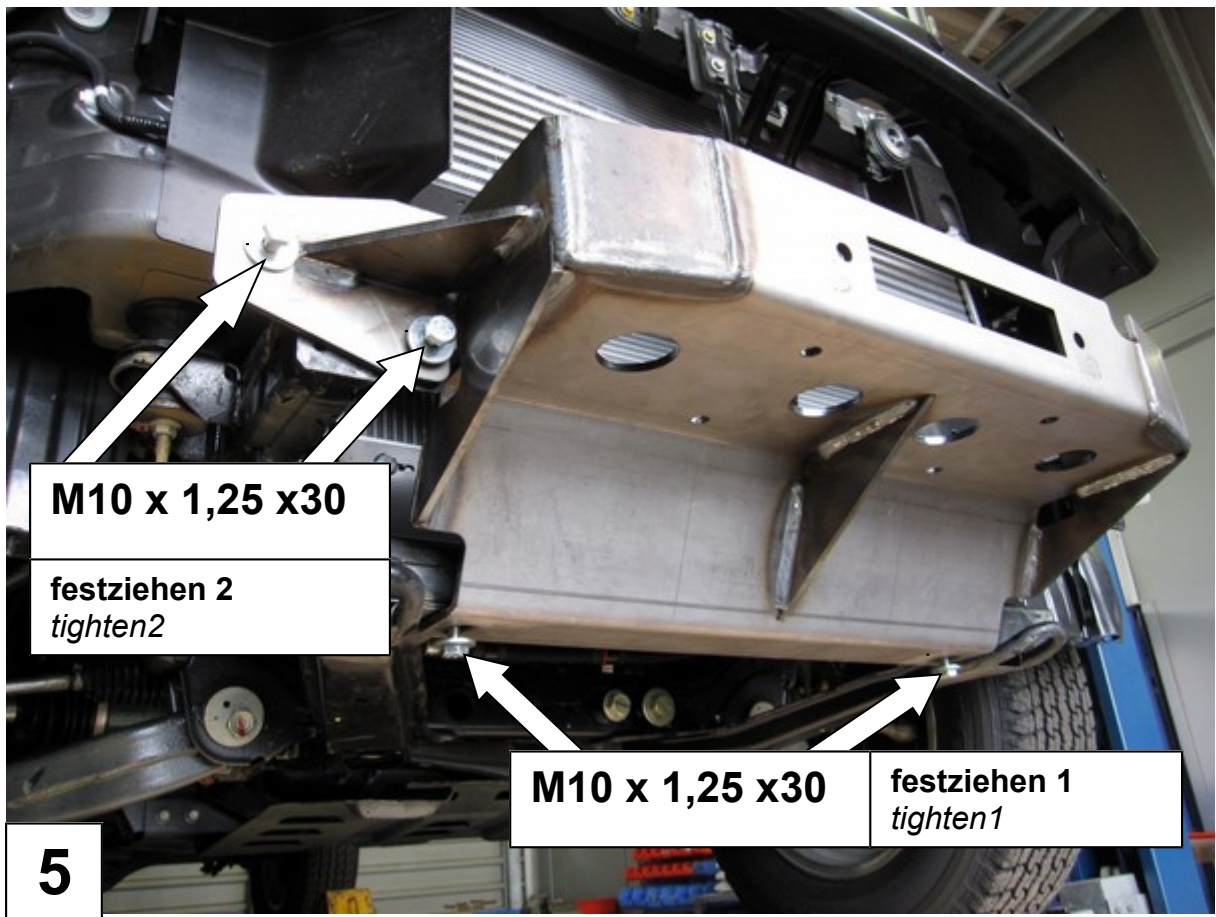

WARN ZEON 8

Lesen Sie unbedingt die Einbauanleitung für das,, (31“) WARN ZEON control pack relocation kit 1- 89965 und der Seilwinde !

Please read the instruction manual of the (31“) WARN ZEON control pack relocation kit 1-89965 and the winch!



7

Demontieren sie den Contactor und die Steckdose der WARN ZEON 8 ,wie in der Einbauanleitung beschrieben.

Disassemble the contactor pack of the WARN ZEON 8 to get just the contactor and the socket.

WARN ZEON 8

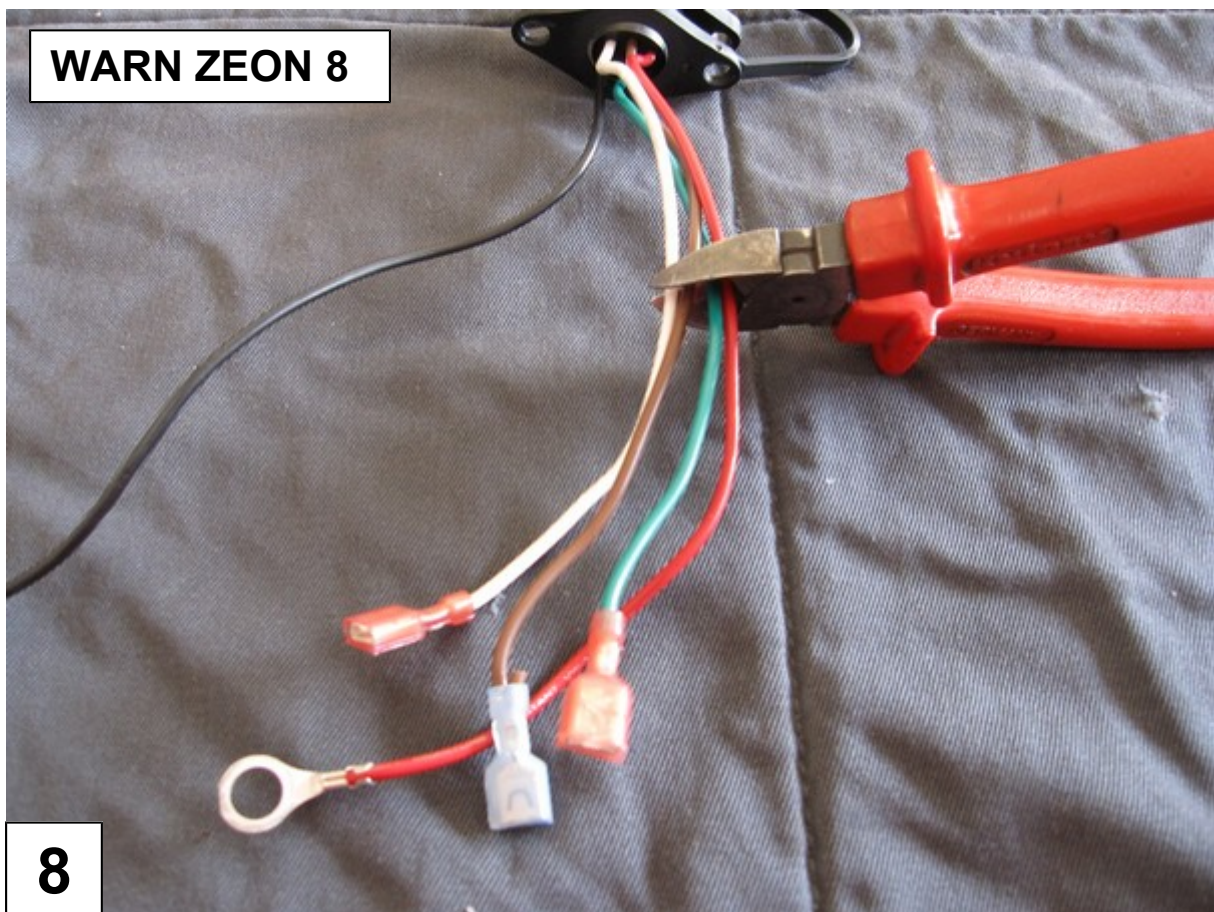

8

WARN ZEON 8

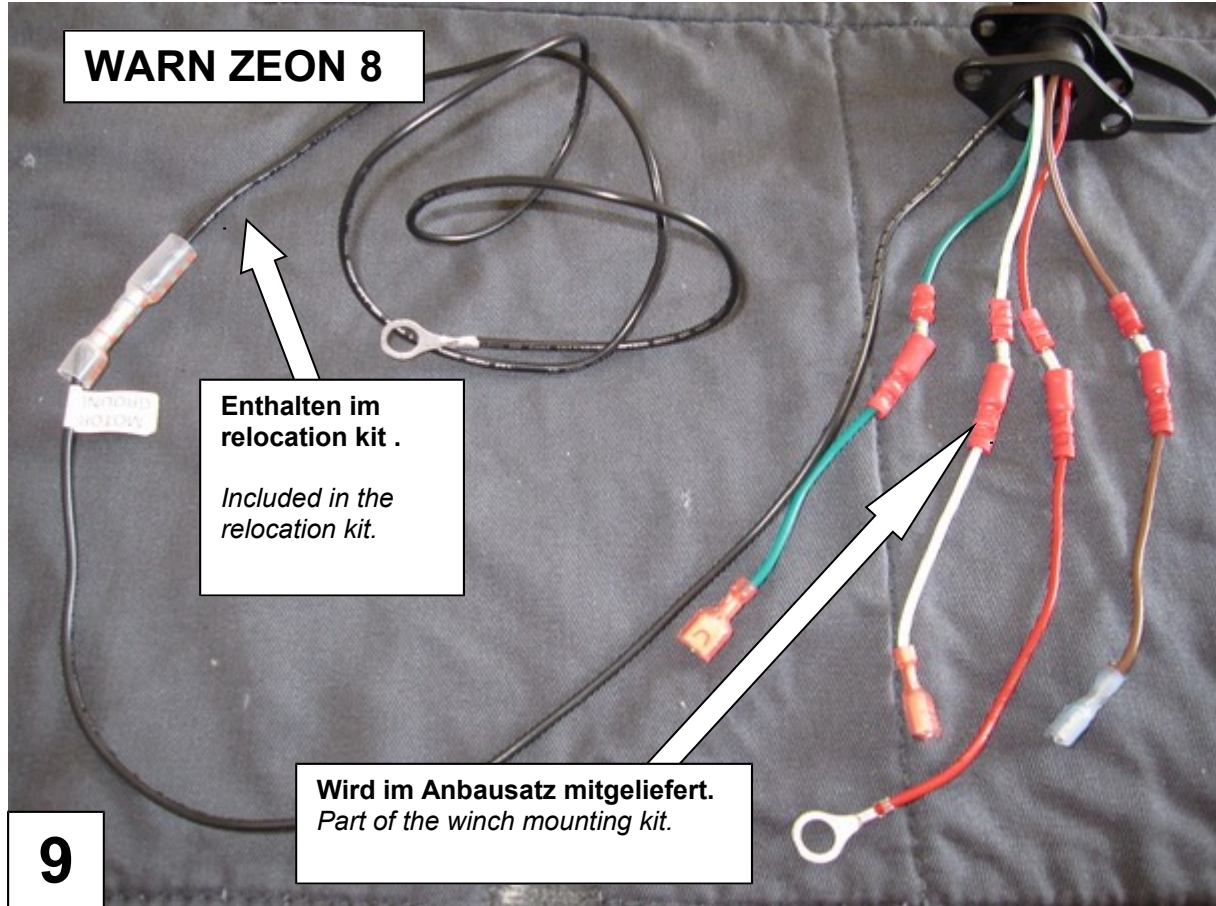

Enthalten im
relocation kit .

*Included in the
relocation kit.*

Wird im Anbausatz mitgeliefert.
Part of the winch mounting kit.

9

WARN ZEON 8

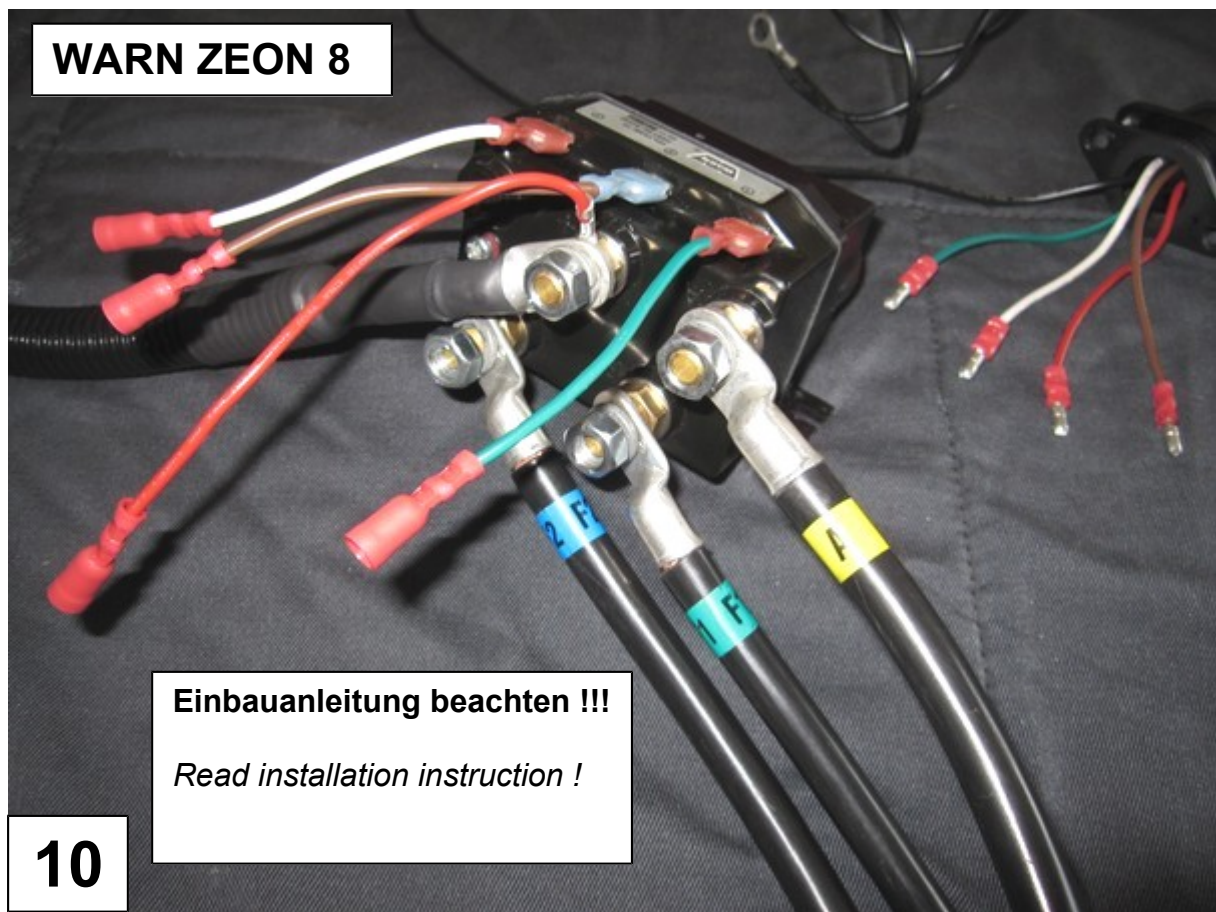

Einbauanleitung beachten !!!

Read installation instruction !

10

WARN ZEON 8

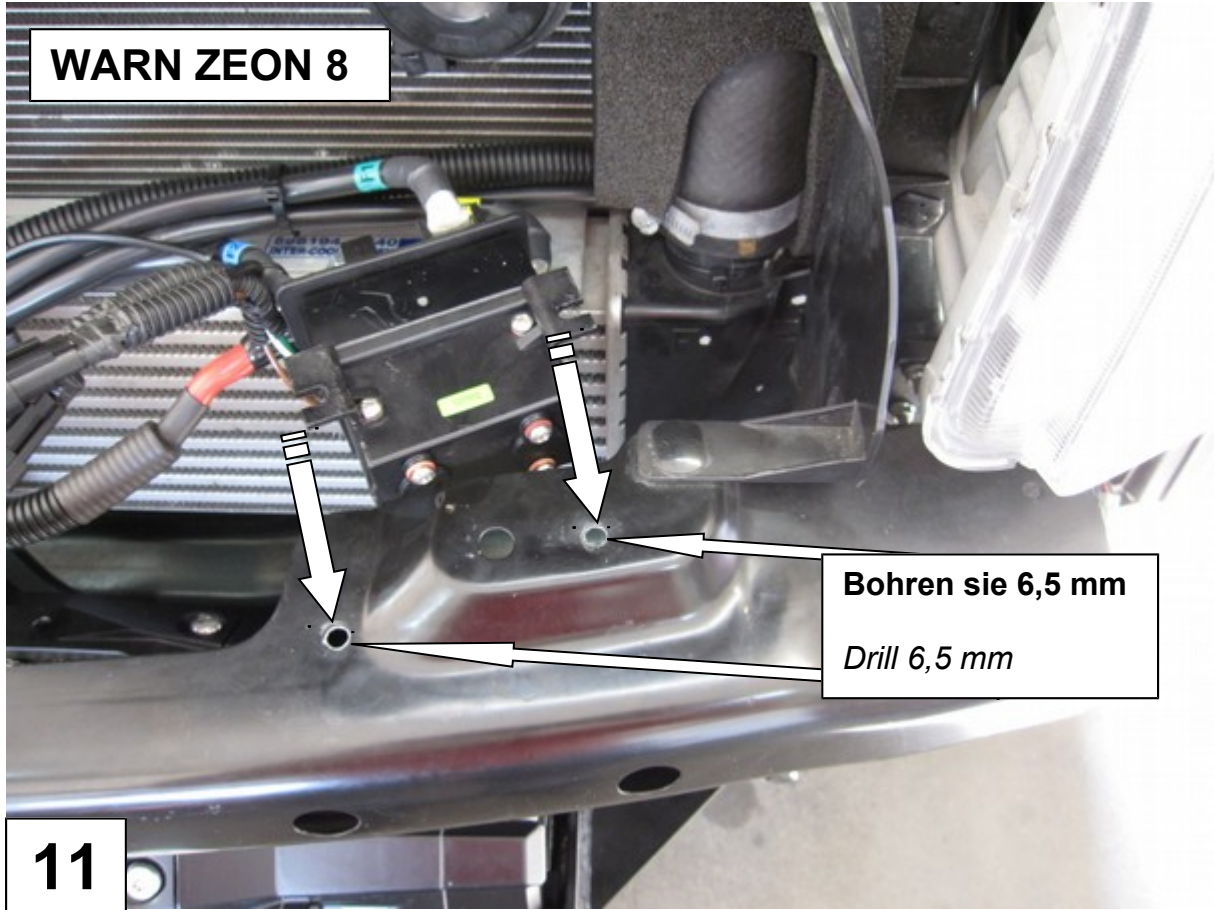

Bohren sie 6,5 mm

Drill 6,5 mm

WARN ZEON 8

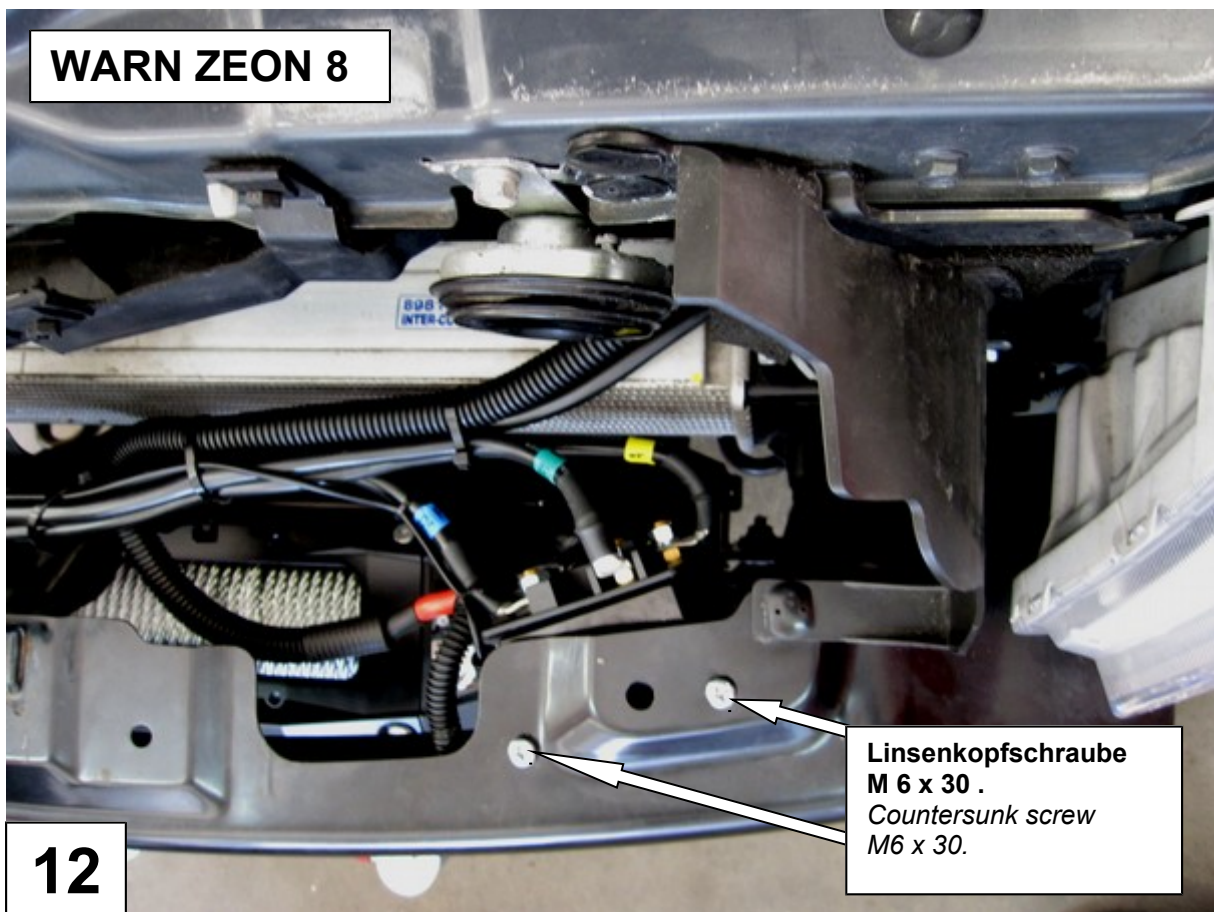

Linsenkopfschraube
M 6 x 30 .

Countersunk screw
M6 x 30.

WARN M 8000

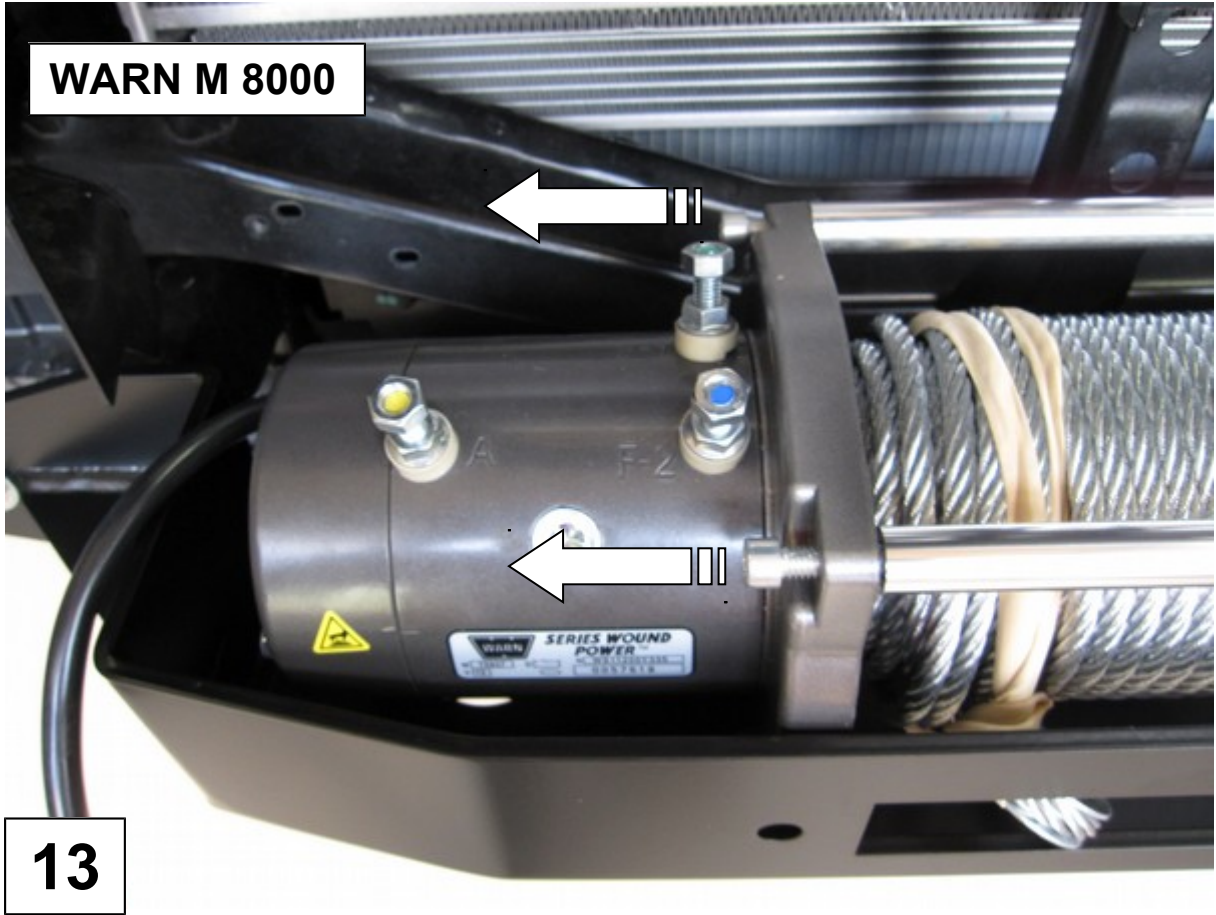

13

WARN M 8000

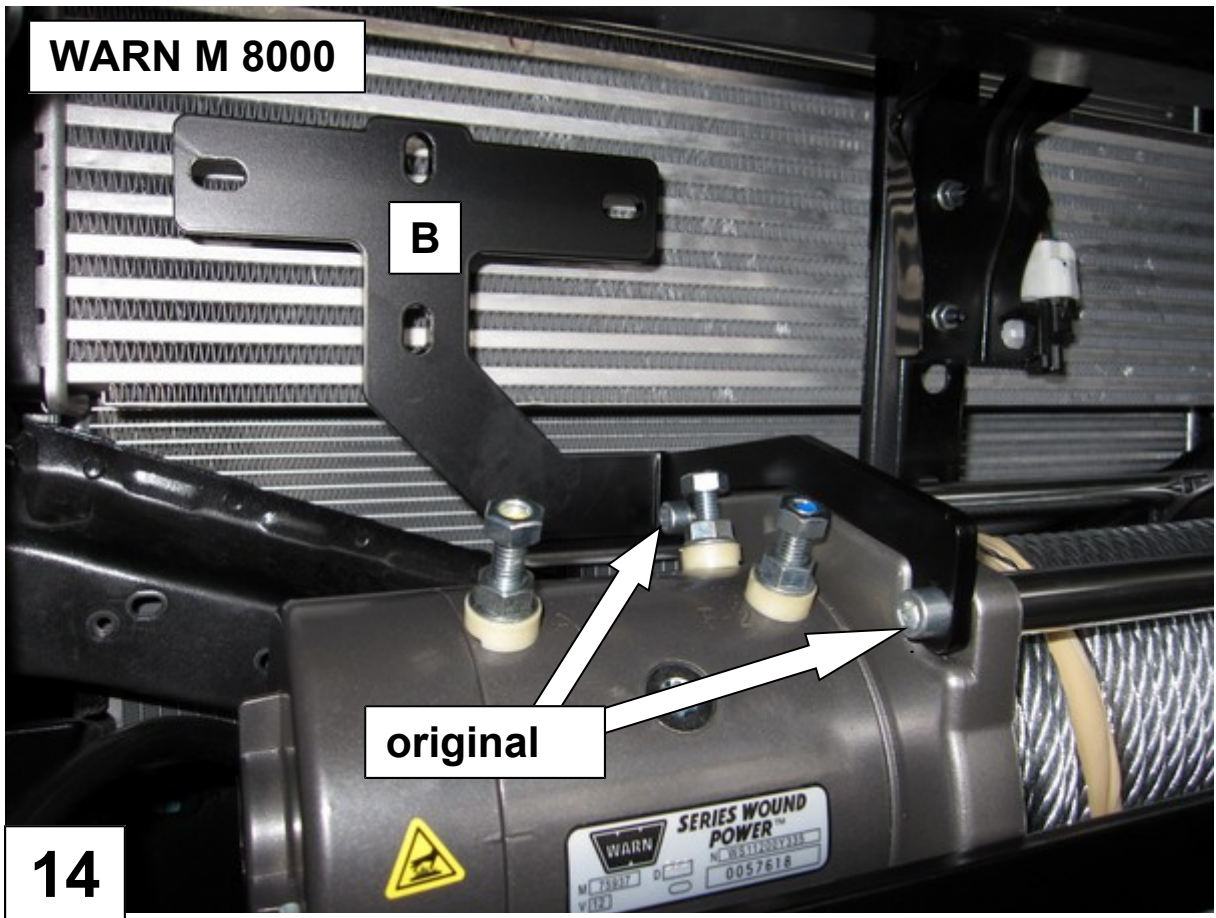

14

WARN M 8000

**Einbauanleitung der
Seilwinde beachten!**

*Please, follow installation
manual of the winch!*



15

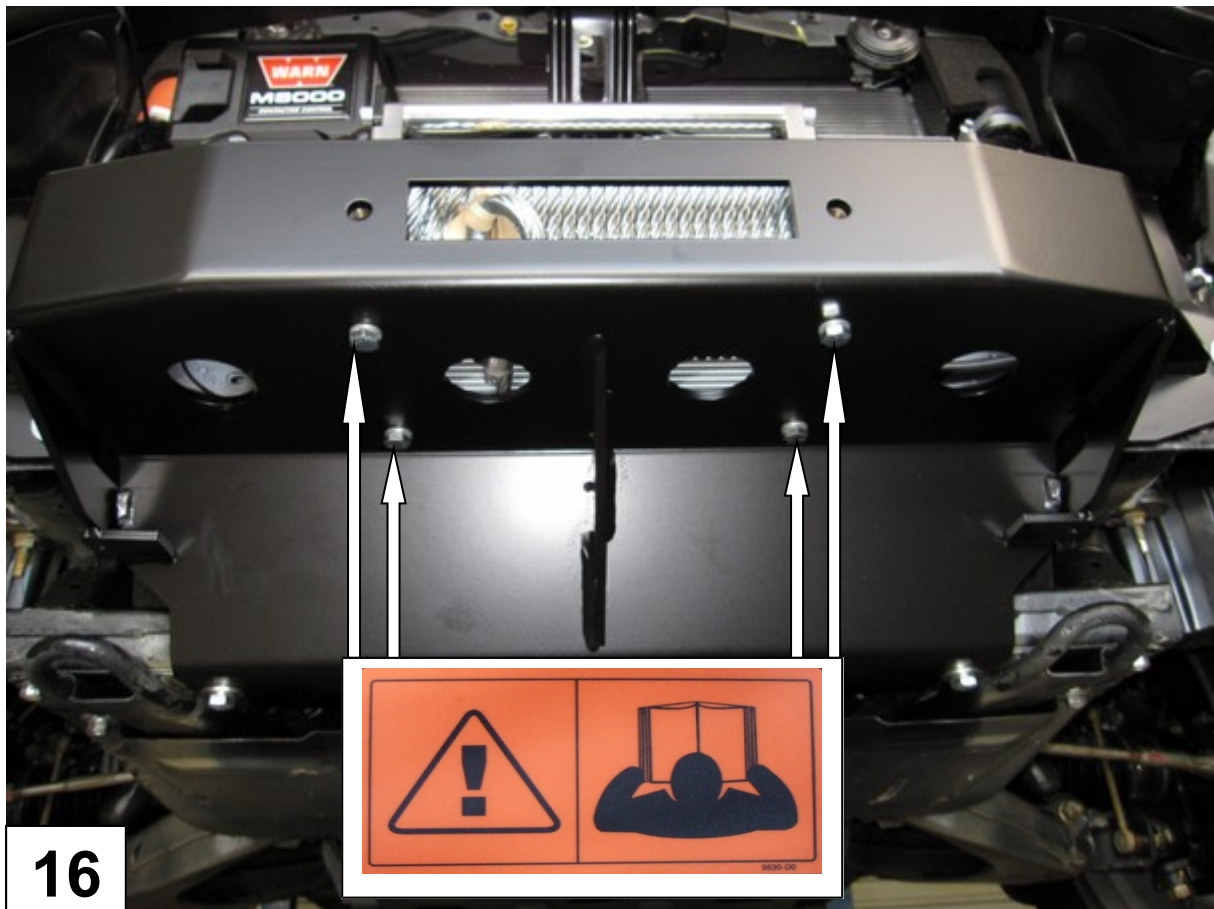

16

Erstellen sie die 11mm Bohrungen für die Seilfensterbefestigungsschrauben!

Drill the 11mm wholes for the fairlead screws!

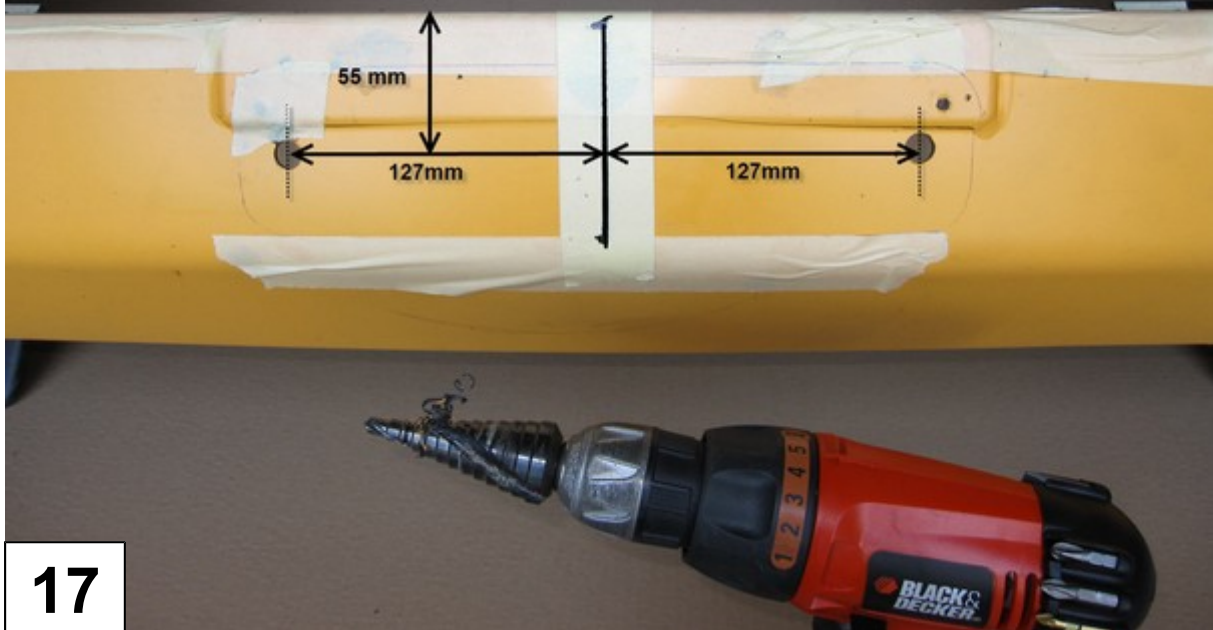

17

Übertragen sie die Maße des von ihnen gewählten Seilfensters auf den Stoßfänger und schneiden sie ihn entsprechend aus !

Use the fairlead of your choice as a template and cut out the bumper accordingly!



18

Übertragen sie die Maße des von ihnen gewählten Seilfensters auf den Stoßfänger und schneiden sie ihn entsprechend aus !

Use the fairlead of your choice as a template and cut out the bumper accordingly!

19



WARN ZEON 8



21

WARN ZEON 8

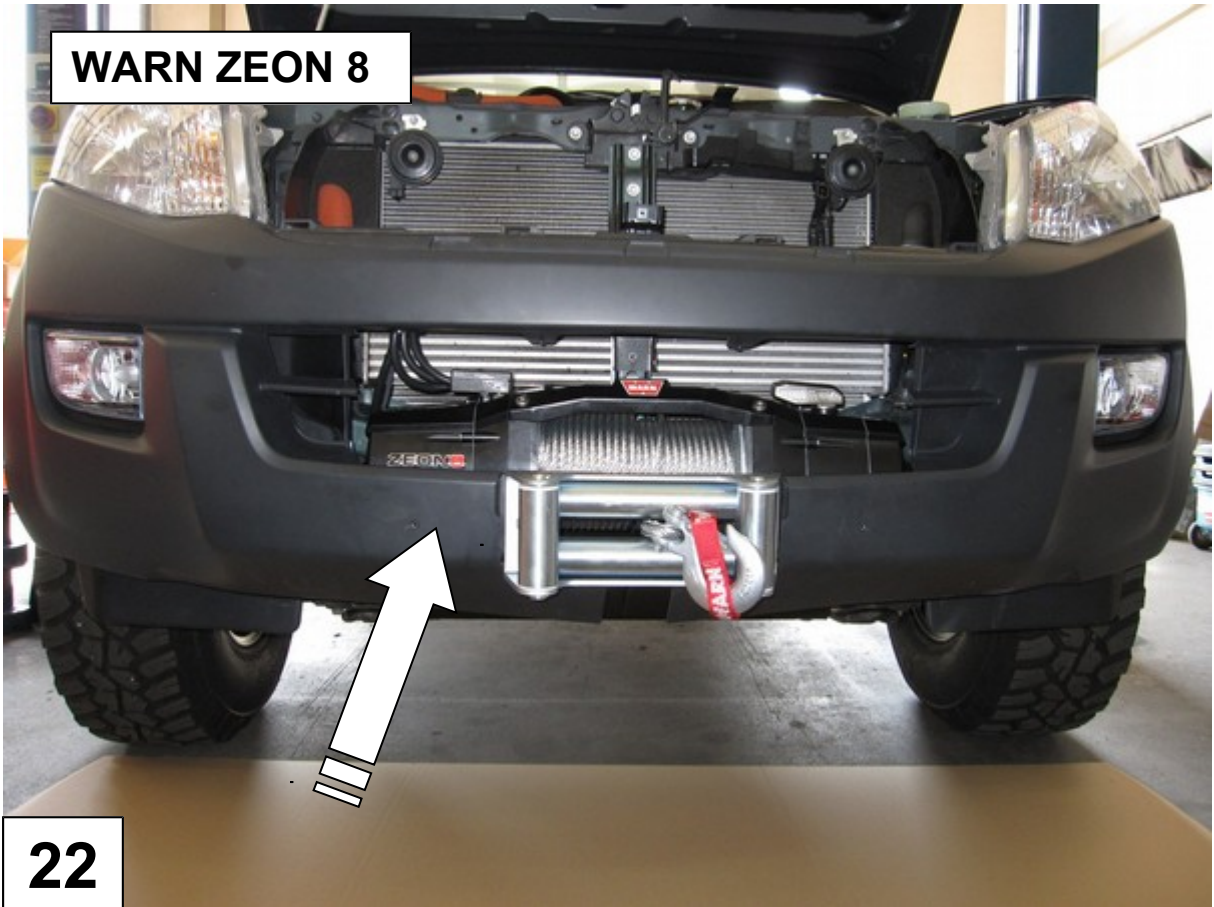

22

WARN ZEON 8

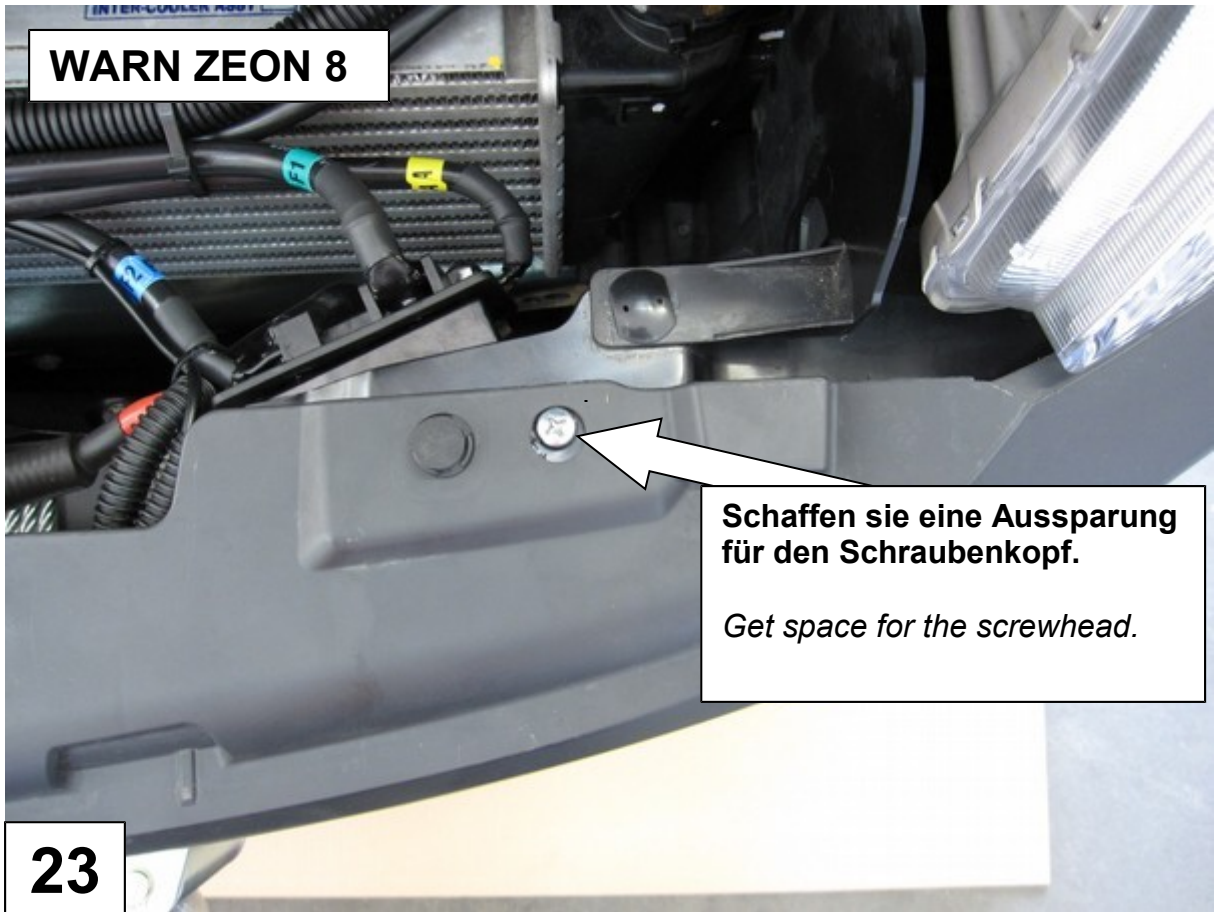

Schaffen sie eine Aussparung für den Schraubenkopf.

Get space for the screwhead.

23

WARN ZEON 8

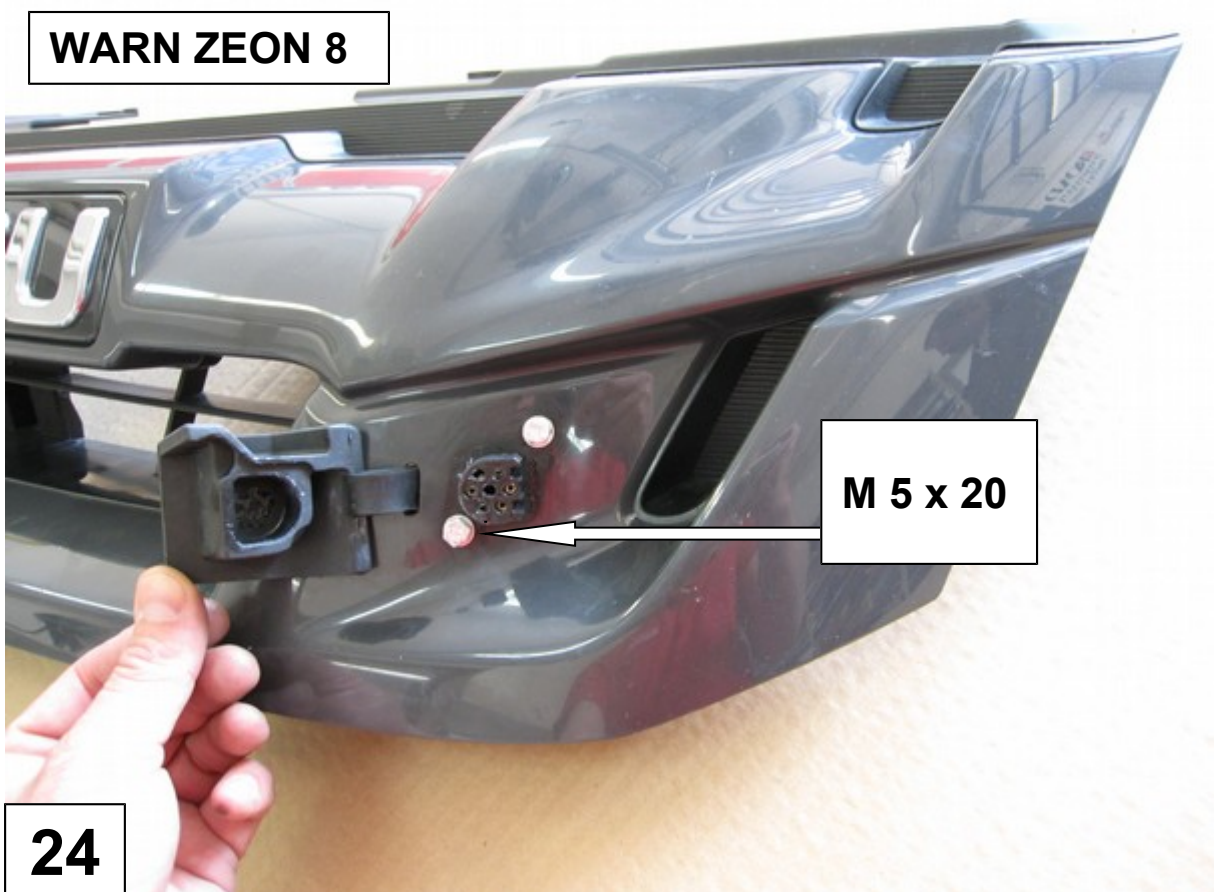

M 5 x 20

24

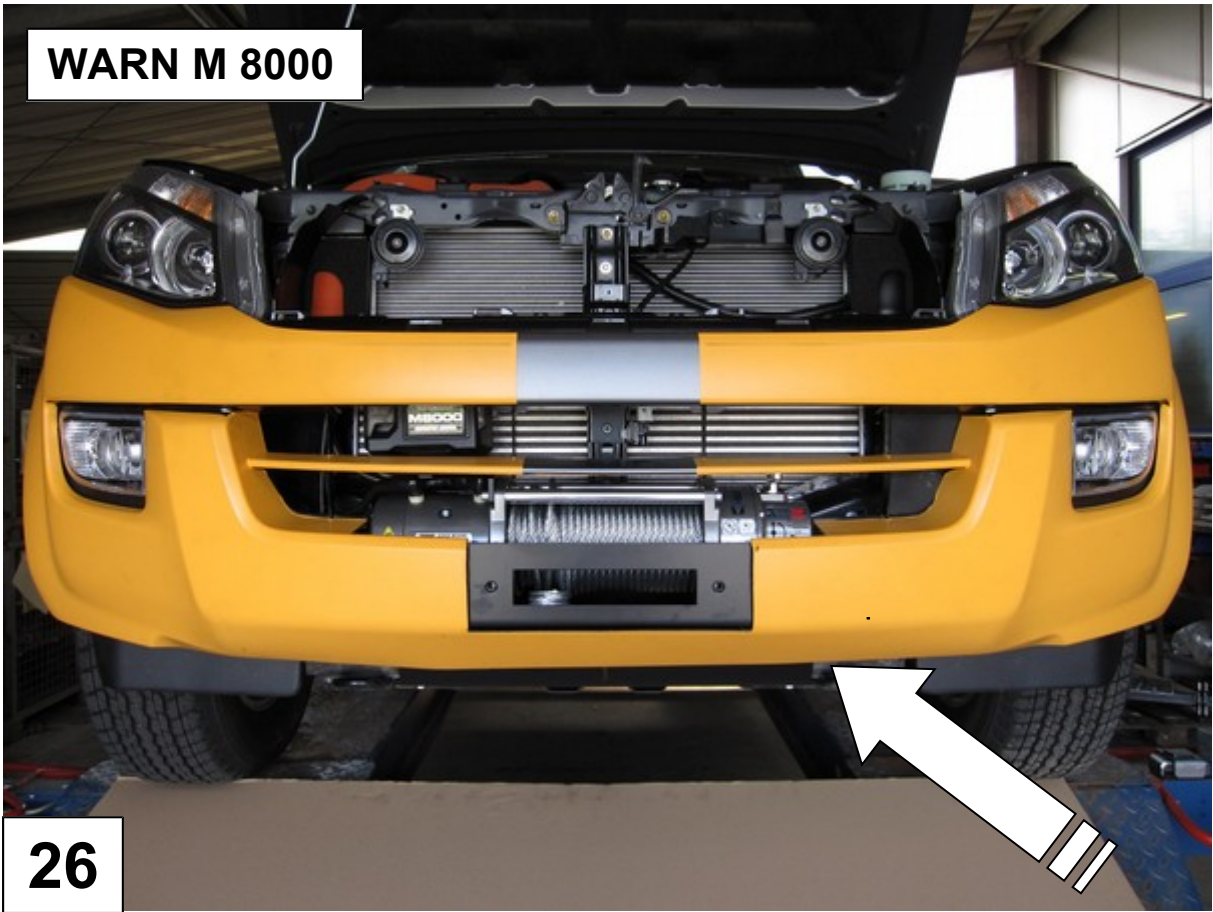

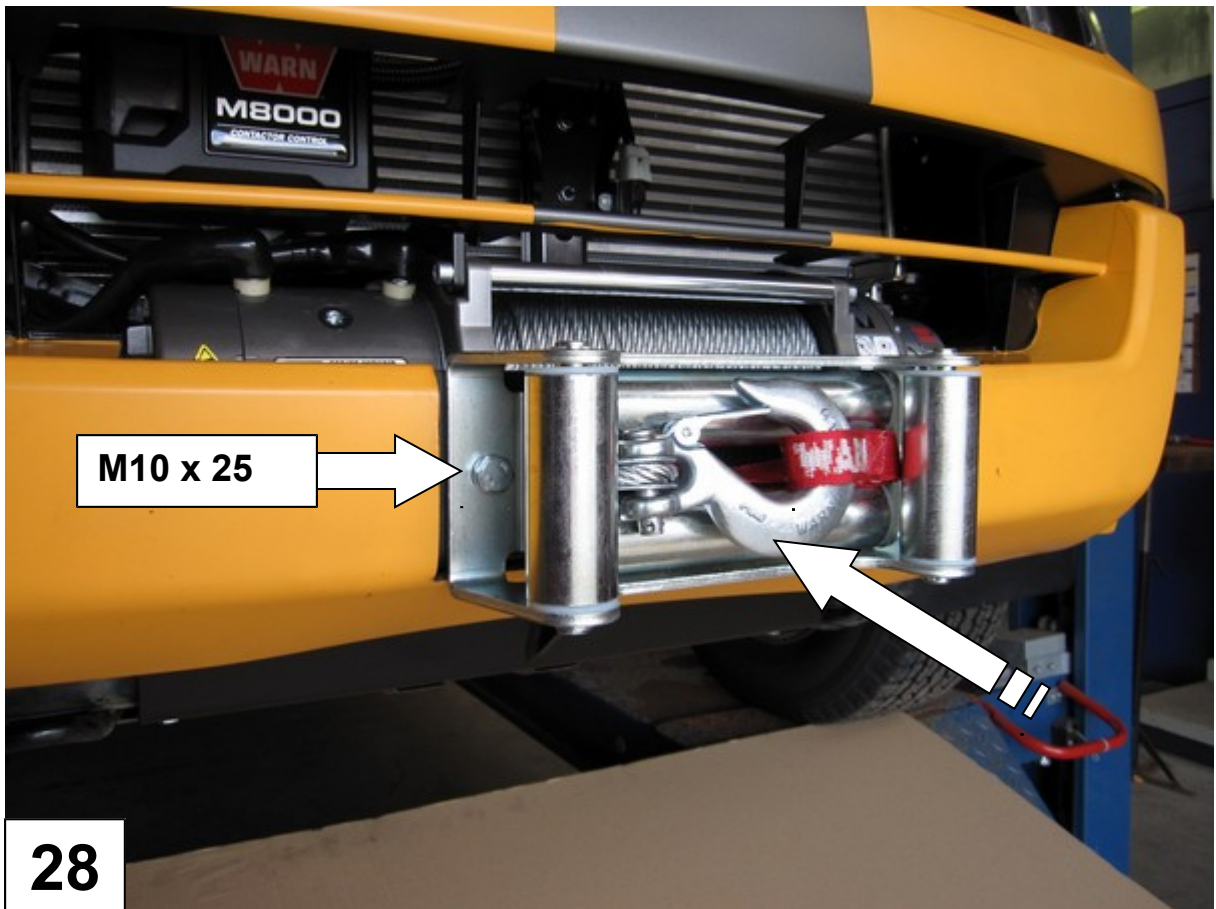
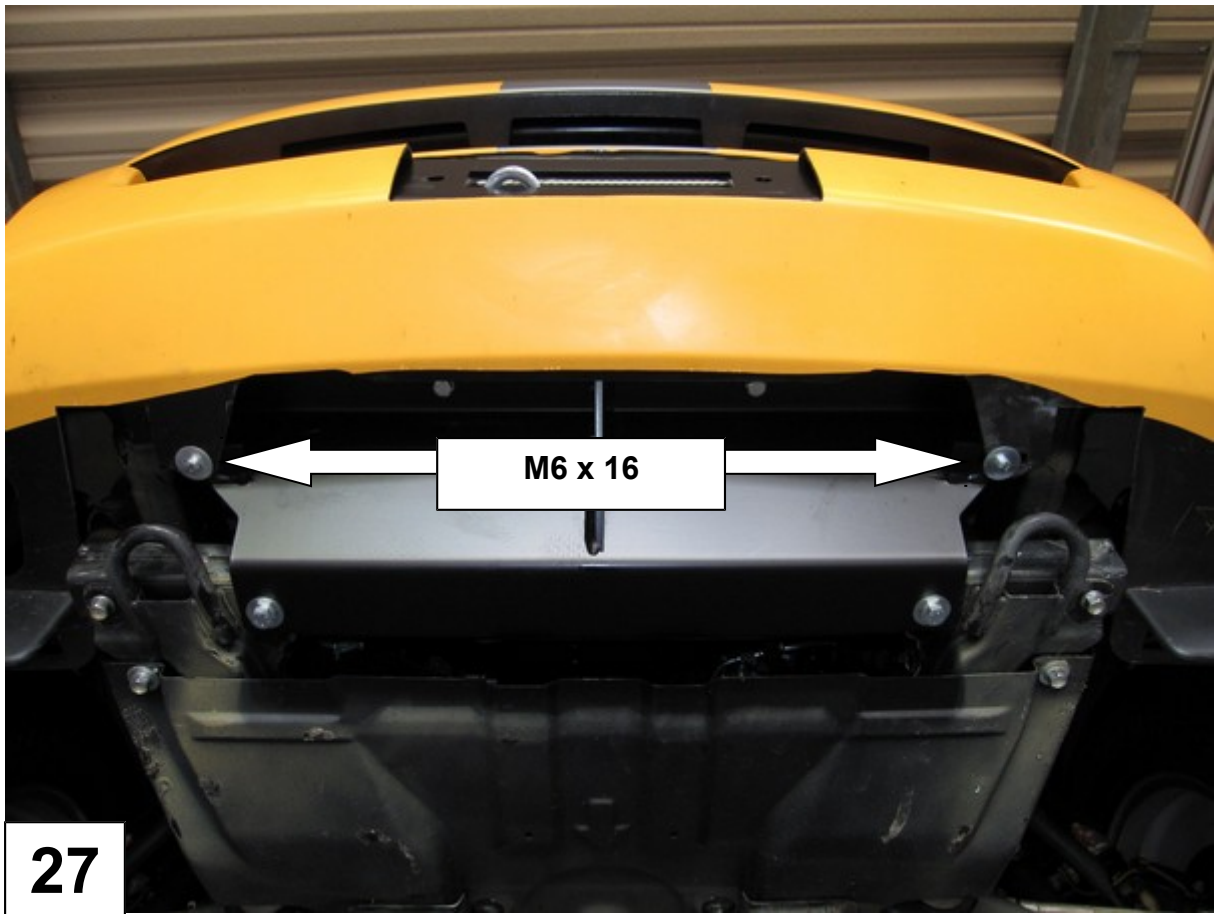

WARN M 8000



29

WARN ZEON 8



30